

80X

PISTOL
USER MANUAL



BERETTA

CONTENTS

BASIC SAFETY RULES	4
CONTROLS	10
AMMUNITION	11
LOADING AND FIRING	12
DESCRIPTION	22
SPECIFICATIONS	23
SAFETY FEATURES	24
OPERATIONAL FEATURES	25
GENERAL OPERATION	28
LOAD CHECK	28
LOCKING THE SLIDE TO THE REAR	29
FIELD STRIPPING	30
RE-ASSEMBLY	32
HOW TO REPLACE THE MAGAZINE RELEASE BUTTON	32
HOW TO REVERSE THE MAGAZINE RELEASE BUTTON	33
AIMING DEVICE	35
MAINTENANCE	39
STORAGE	41
TROUBLE-SHOOTING	42
PARTS LISTING	44

WARNING, CAUTION and Notice headings are defined as follows:

 **WARNING:**

The purpose of a **WARNING** is to draw attention to a potential dangerous situation that could result in personal injury.

 **CAUTION:**

A **CAUTION** concerns potential damage to firearm.

 **Notice:**

A **NOTICE** highlights important procedures and statements that require more emphasis than general text.

Illustrations in the manual refer to 80X pistol.

The references “left” or “right” always refer to the firearm as hold by the user.

The contents of this manual are subject to change without notice.

⚠ Notice: always keep this manual with your firearm. Include it with the pistol when it changes ownership or when it is loaned or presented to another person.

⚠ Notice: The Manufacturer and/or its Local Official Distributors assume no responsibility for product malfunction or for physical injury or property damage resulting in whole or in part from criminal or negligent use of the product, improper or careless handling, unauthorized modifications, use of defective, improper, hand-loaded, reloaded or remanufactured ammunition*, customer abuse or neglect of the product, or other influences beyond manufacturer's direct and immediate control.

* See paragraph "Ammunition".

⚠ WARNING: always ensure safety is engaged – if present until ready to fire. A safety, which is not fully engaged, will not prevent firearm discharge.

⚠ WARNING: ALL FIREARMS HAVE LETHAL POTENTIAL. READ THE BASIC SAFETY RULES CAREFULLY AND UNDERSTAND THEM FULLY BEFORE ATTEMPTING TO USE THIS FIREARM.

⚠ Notice: In addition to the Basic Safety Rules, there are other Safety Rules pertaining to the loading, unloading, disassembly, assembly and use of this firearm, located throughout this manual.

⚠ WARNING: READ THE ENTIRE MANUAL CAREFULLY BEFORE USING THIS FIREARM. MAKE SURE THAT ANY PERSON USING OR HAVING ACCESS TO THIS FIREARM READS AND UNDERSTANDS ALL OF THIS MANUAL PRIOR TO USE OR ACCESS.

⚠ CAUTION: we recommend the use of original Beretta spare parts and accessories. The use of other manufacturer's spare parts and accessories could cause malfunctions and/or breakages that will not be covered by the Beretta warranty.

BASIC SAFETY RULES

⚠ WARNING: PLEASE READ THIS MANUAL BEFORE HANDLING YOUR FIREARM.

⚠ WARNING: FIREARMS CAN BE DANGEROUS AND CAN POTENTIALLY CAUSE SERIOUS INJURY, DAMAGE TO PROPERTY OR DEATH, IF HANDLED IMPROPERLY. THE FOLLOWING SAFETY RULES ARE AN IMPORTANT REMINDER THAT FIREARM SAFETY IS YOUR RESPONSIBILITY.

1. NEVER POINT A FIREARM AT SOMETHING THAT IS NOT SAFE TO SHOOT.

Never let the muzzle of a firearm point at any part of your body or at another person. This is especially important when loading or unloading the firearm. When you are shooting at a target, know what is behind it. Some bullets can travel over a mile. If you miss your target or if the bullet penetrates the target, it is your responsibility to ensure that the shot does not cause unintended injury or damage.



2. ALWAYS TREAT A FIREARM AS IF IT WERE LOADED.

Never assume that a firearm is unloaded. The only certain way to ensure that a firearm has the chamber(s) empty is to open the chamber and visually and physically examine the inside to see if a round is present. Removing or unloading the

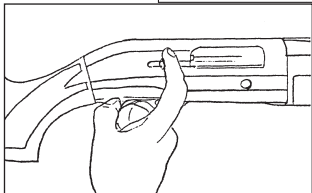
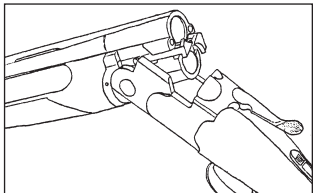
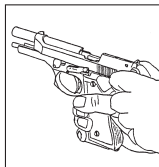

magazine will not guarantee that a firearm is unloaded or cannot fire. Firearms can be checked by cycling or removing all rounds and by then opening and inspecting the chamber so that a visual inspection of the chamber for any remaining rounds can be made.

3. STORE YOUR FIREARM SO THAT CHILDREN CANNOT GAIN ACCESS TO IT.

It is your responsibility to ensure that children under the age of 18 or other unauthorized persons do not gain access to your firearm. To reduce the risk of accidents involving children, unload your firearm, lock it and store the ammunition in a separate locked location. Please note that devices intended to prevent accidents - for example, cable locks, chamber plugs, etc, - may not prevent use or misuse of your firearm by a determined person. Firearm storage in a steel gun safe may be more appropriate to reduce the likelihood of intentional misuse of a firearm by an unauthorized child or person.

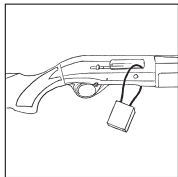
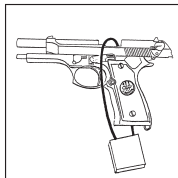

4. NEVER SHOOT AT WATER OR AT A HARD SURFACE.

Shooting at the surface of water or at a rock or other hard surface increases the chance of ricochets or fragmentation of the bullet or shot, which can result in the projectile striking an unintended or peripheral target.



5. KNOW THE SAFETY FEATURES OF THE FIREARM YOU ARE USING, BUT REMEMBER: SAFETY DEVICES ARE NOT A SUBSTITUTE FOR SAFE HANDLING PROCEDURES.

Never rely solely on a safety device to prevent an accident. It is imperative that you know and use the safety features of the particular firearm you are handling, but accidents can best be prevented by following the safe handling procedures described in these safety rules and elsewhere in the product manual. To further

familiarize yourself with the proper use of this or other firearms, take a Firearms Safety Course taught by an expert in firearms use and safety procedures.

6. PROPERLY MAINTAIN YOUR FIREARM.

Store and carry your firearm so that dirt or lint does not accumulate in the working parts. Clean and oil your firearm, following the instructions provided in this manual, after each use to prevent corrosion, damage to the barrel or accumulation of impurities which can prevent use of the gun in an emergency. Always check the bore and chamber(s) prior to loading to ensure that they are clean and free from obstructions. Firing with an obstruction in the barrel or chamber can rupture the barrel and injure you or others nearby. In the event you hear an unusual noise when shooting, stop firing immediately, engage the manual safety and unload the firearm. Make sure the chamber and barrel are free from any obstruction, like a bullet blocked inside the barrel due to defective or improper ammunition.



7. USE PROPER AMMUNITION.

Only use factory-loaded, new ammunition manufactured to industry specifications: CIP (Europe and elsewhere), SAAMI® (U.S.A.). Be certain that each round you use is in the proper caliber or gauge and type for the particular firearm. The caliber or gauge of the firearm is clearly marked on the barrels of shotguns and on the slide or barrel of pistols. The use of reloaded or remanufactured ammunition can increase the likelihood of excessive cartridge pressures, case-head ruptures or other defects in the ammunition that can cause damage to your firearm and injury to yourself or others nearby.

8. ALWAYS WEAR PROTECTIVE GLASSES AND EARPLUGS WHEN SHOOTING.

The chance that gas, gunpowder or metal fragments will blow back and injure a shooter who is firing a gun is rare, but the injury that can be



sustained in such circumstances can be severe, including the possible loss of eyesight. A shooter must always wear impact resistant shooting glasses when firing any firearm. Earplugs or other high-quality hearing protectors help reduce the chance of hearing damage from shooting.

9. NEVER CLIMB A TREE, FENCE OR OBSTRUCTION WITH A LOADED FIREARM.

Open and empty the chamber(s) of your firearm and engage the manual safety before climbing or descending a tree or before climbing a fence or jumping over a ditch or other obstruction. Never pull or push a loaded firearm toward yourself or another person. Always unload a firearm, visually and physically check to see that the magazine, loading mechanism and chamber are unloaded, and action is open before handing it to another person. Never take a firearm from another person unless it is unloaded, visually and physically checked to confirm it is unloaded, and the action is open.



10. AVOID ALCOHOLIC BEVERAGES OR JUDGMENT/REFLEX IMPAIRING MEDICATION WHEN SHOOTING.

Do not drink and shoot. If you take medication that can impair motor reactions or judgment, do not handle a firearm while you are under the influence of the medication.



11. NEVER TRANSPORT A LOADED FIREARM.

Unload a firearm before putting it in a vehicle (chamber empty, magazine empty). Hunters and target shooters should load their firearm only at their destination, and only when they are ready to shoot. If you carry a firearm for self-protection, leaving the chamber unloaded can reduce the chance of an unintentional discharge.



12. LEAD WARNING.

Discharging firearms in poorly ventilated areas, cleaning firearms, or handling ammunition may result in exposure to lead and other substances known to cause birth defects, reproductive harm, and other serious physical injury. Have adequate ventilation at all times. Wash hands thoroughly after exposure.

⚠ WARNING: It is **YOUR** responsibility to know and abide by Federal, State and Local laws governing the sale, transportation and use of firearms in your area.

⚠ WARNING: This firearm has the capability of taking your life or the life of someone else! Always be extremely careful with your firearm. An accident is almost always the result of not following basic firearm safety rules.

ESPECIALLY FOR U.S. CONSUMERS:

For information about Firearm Safety Courses in your area, please visit the National Rifle Association's web site at www.nra.org.

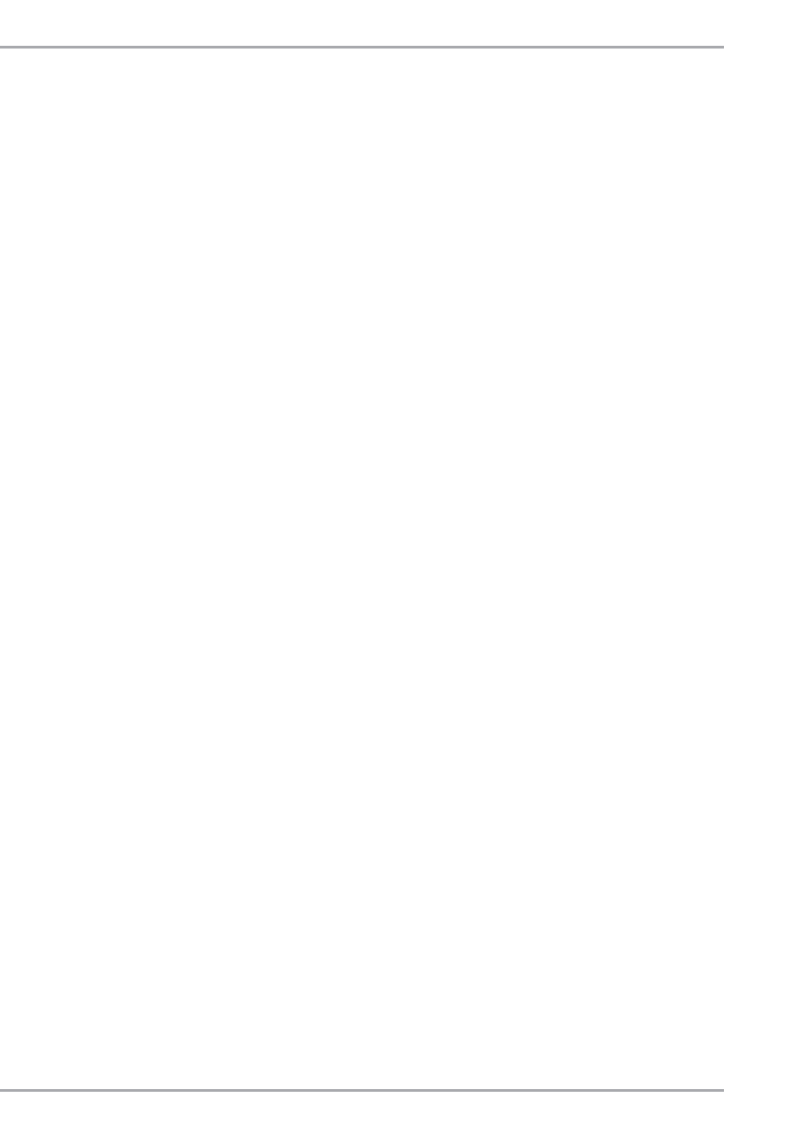

CONTROLS

The following figures are side views of the 80X pistol showing the main controls.

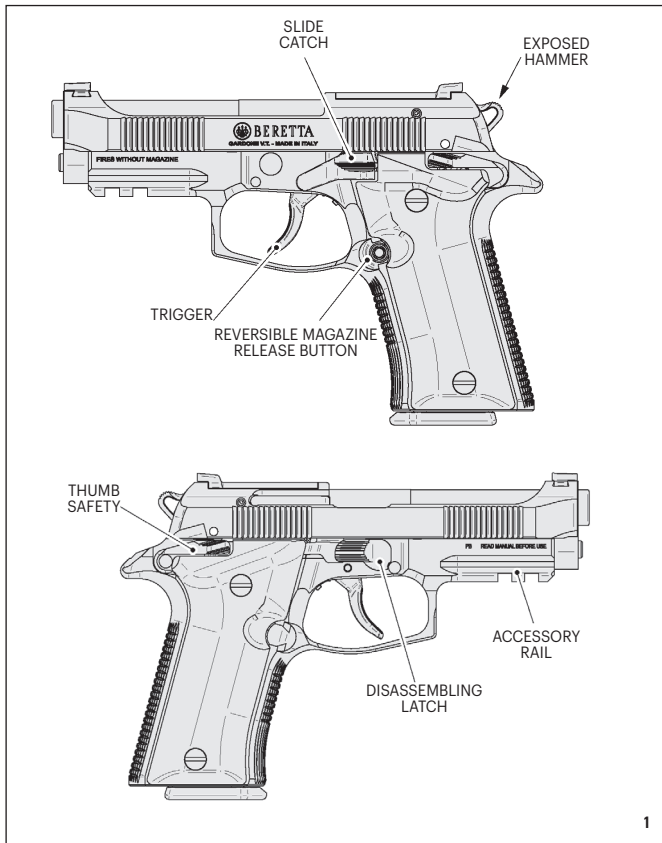

AMMUNITION

AMMUNITION (CARTRIDGE)

NOTICE:

Beretta specifically disclaims responsibility for any damage or injury occurring with, or as the result of, the use of faulty, non-standard, “remanufactured,” hand-loaded or reloaded ammunition, or cartridges other than those for which the firearm was originally chambered. Serious damage or injury, even death, could result from the use of incorrect ammunition, from firing against bore obstructions and from propellant overloads. Use of improper ammunition, such as listed previously will void the manufacturer’s warranty. Use only high-quality, commercially-manufactured ammunition made in accordance with CIP (Europe and elsewhere) or SAAMI® (USA) standards. Be certain that the ammunition is the appropriate caliber and loading for the firearm and is clean, dry and in good condition. The pistol caliber is stamped on the back of the barrel, visible from the ejection port.

⚠ WARNING: Carefully inspect each cartridge before it is loaded in the magazine. Be certain the cartridge cases are not split or deformed, and that the cartridges do not possess any other dents or defects. This warning even applies to factory ammunition.

Do not fire old ammunition. Primers, powder, cartridge cases, and bullets can deteriorate with time and cause damage to the firearm, or injury to the shooter or others.

⚠ WARNING: Lead bullets have a tendency to cause bore leading, which may dramatically increase the discharge pressure. Be sure to remove all chamber and bore lead accumulation after each use. **DO NOT** shoot cartridges with jacketed bullets through a barrel previously fired with lead bullets before the bore is thoroughly de-leaded.

DRY FIRING & “DUMMY” ROUNDS

Dry firing is defined as firing a firearm with no ammunition in the chamber. Long term dry firing your Beretta 80X pistol may result in damage to the firing pin. “Snap Caps” (inert chamber inserts that allow a firearm to be dry-fired without damaging the action) are available at most gun stores for those who wish to practice firing without live ammunition.

 **CAUTION:** “Dummy Rounds” with empty primer pockets are suitable for loading/unloading practice but **DO NOT PROTECT** the firing pin tip during dry firing.

LOADING AND FIRING

 **WARNING:** A pistol can have a live round in the chamber and can fire even if the magazine is empty or has been removed.

 **WARNING:** Before loading the firearm, become familiar with the following loading procedures without the use of ammunition. Never handle a loaded firearm until you are fully familiar with the loading procedures. Always point the firearm in a safe direction.

 **WARNING:** Always keep your finger away from the trigger whenever you do not intend to fire.

 **WARNING:** Load the chamber only when ready to fire. In case of interruption of firing before the magazine is empty and the chambered round is fired, it is necessary to unload the pistol before decocking the hammer.

LOADING THE MAGAZINE

⚠ WARNING: Be sure that you have the correct cartridges for your pistol.

To load the magazine, remove it from the pistol by depressing the magazine release button.

Hold the magazine in one hand. With the other hand place a cartridge on the magazine follower in front of the lips at the top of the magazine. Press the cartridge down onto the follower and slide the cartridge completely under the lips until it is lodged fully inside the magazine body.

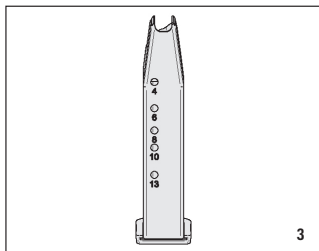
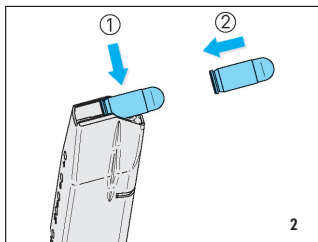

Repeat process until magazine is fully loaded. Holes on the back of the magazine allow for visual counting of cartridges.

⚠ CAUTION: Do not try to force more than the maximum number of rounds indicated for your particular pistol into the magazine. An overloaded magazine may not function properly.

LOADING THE PISTOL AND THE FIRING CHAMBER

⚠ WARNING: Beretta assumes no responsibility for any injury or property damage resulting from improper or careless handling, intentional or accidental discharge of the firearm.

⚠ WARNING: Be sure that the obstruction check has been completed prior to loading.

⚠ WARNING: Point the firearm in a safe direction. Do not touch the trigger until you are ready to fire and are sure of your target and backstop.

The firing chamber of the pistol is the portion of the barrel into which the cartridge is fed. The firing chamber may be loaded in one of two ways:

1. LOADING FROM MAGAZINE

Push the loaded magazine into the pistol grip completely to insure catch engagement.

Release the thumb safety, if engaged.

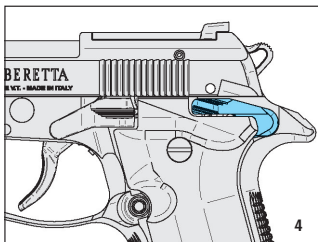

Pull back the slide and release it. The slide will automatically pick up a cartridge from the top of the magazine and feed it into the chamber.

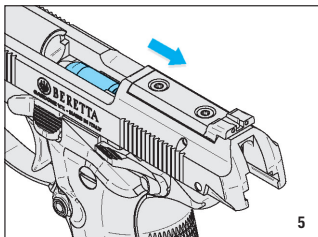

⚠ WARNING: THE PISTOL IS NOW CHAMBER LOADED, COCKED, THUMB SAFETY DISENGAGED AND READY TO FIRE BY PULLING THE TRIGGER.

IF YOU ARE NOT READY TO FIRE
Engage the thumb safety by rotating the safety lever with a fully upward thumb pressure, so as to cover the red warning dot (the red dot is visible when the thumb safety is disengaged), causing the hammer to decock and rest on the hammer stop.

⚠ WARNING: Always ensure that the safety is fully engaged until ready to fire. A safety is fully engaged only when the safety can move no further into the safe position. A safety which is not fully engaged will not prevent weapon discharge.

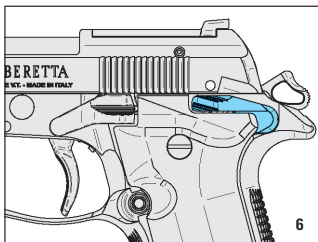

2. A PISTOL WHICH IS LOADED AND FIRED WILL AUTOMATICALLY PICK UP THE NEXT ROUND AND FEED IT INTO THE FIRING CHAMBER AS LONG AS THERE IS AMMUNITION IN THE MAGAZINE.

If you want to replace the round which has been chambered from the magazine (remember that you are handling a loaded firearm with a live round in the chamber):

Check the thumb safety is engaged.

⚠ WARNING: Always ensure that the safety is fully engaged until ready to fire. A safety is fully engaged only when the safety can move no further into the safe position. A safety which is not fully engaged will not prevent weapon discharge.

Remove the magazine from the pistol by depressing the magazine release button.

Insert one more cartridge into the magazine.

Completely push the loaded magazine into the pistol grip to insure catch engagement.

⚠ WARNING: REMEMBER THAT YOU ARE HANDLING A LOADED FIREARM, WITH A LIVE ROUND IN THE CHAMBER. Keep your finger away from the trigger whenever you do not intend to fire.

UNLOADING

⚠ Notice: It is a good practice to store the pistol unloaded, with empty magazine, with empty chamber and with decocked hammer.

⚠ WARNING: Always point the firearm in a safe direction. Keep your finger away from the trigger.

Make sure that the safety is engaged.

⚠ WARNING: Always ensure that the safety is fully engaged until ready to fire. A safety is fully engaged only when the safety can move no further into the safe position. A safety which is not fully engaged will not prevent weapon discharge.

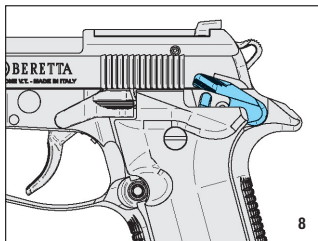

Keep the pistol pointed in a safe direction and remove the magazine from the pistol.

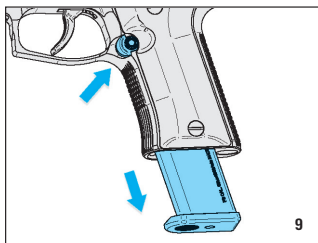

Release the thumb safety and grasping the slide serrations with thumb and index finger, fully retract the slide to remove the chambered cartridge.

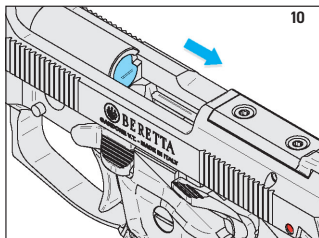

⚠ WARNING: Always visually inspect the firing chamber to ensure that it is empty. The chamber is empty when no cartridge is visible when looking into the open chamber.

When sure that the chamber is empty and the cartridge has been ejected, release the slide.

⚠ WARNING: Releasing the fully retracted slide when a loaded magazine is in the pistol will feed a cartridge into the pistol's firing chamber. Having the hammer cocked, the pistol will be in the condition of being able to fire immediately.

To increase the service life of the hammer spring, it is advisable to lower the hammer.

Engage the thumb safety by rotating the safety lever with a fully upward thumb pressure, so as to cover the red warning dot (the red dot is visible when the thumb safety is disengaged), causing the hammer to de-cock and rest on the hammer stop.

⚠ WARNING: Always ensure that the safety is fully engaged until ready to fire. A safety is fully engaged only when the safety can move no further into the safe position. A safety which is not fully engaged will not prevent weapon discharge.

UNLOADING THE MAGAZINE

To unload the magazine, grasp it with one hand around the magazine box, bottom down and front end forward. With the tip of the thumb firmly press down on the cartridge rim and push towards the front of magazine box. As the cartridge moves forward, tip it slightly upward with the index finger.

Repeat until the magazine is unloaded.

FIRING

⚠ WARNING: Beretta assumes no responsibility for any injury or property damage resulting from improper or careless handling, intentional or accidental discharge of the firearm.

⚠ WARNING: Be certain the firearm is pointed in a **SAFE** direction. Never put your finger on the trigger unless you intend to shoot.

⚠ WARNING: High-quality eye and ear protection should be worn by all present when firing any firearm.

WHEN READY TO FIRE:

Aim the pistol by aligning the top of the front sight with the top of the rear sight. Place the front sight on your target. This is your point of aim.

Release the thumb safety by simply pushing the thumb safety lever down all the way.

The Red Warning Dot, which is exposed when the safety lever is rotated completely downward, indicates that the safety is off.

⚠ WARNING: THE PISTOL IS NOW READY TO FIRE.

⚠ WARNING: Ensure that fingers or other parts of the hands and the face are kept away from the slide. Not respecting this warning can lead to serious injury. During the firing cycle, the slide moves to the rear violently and with great energy. Ensure that the other hand is kept away from the muzzle of the barrel.

Fire by squeezing the trigger.

ⓘ Notice: If the hammer is uncocked, the pull of the trigger will cock and then release the hammer, letting it strike the firing pin. This firing mode is called double action.

ⓘ Notice: If the hammer is cocked, the pull on the trigger simply releases the hammer letting it strike the firing pin. This firing mode is called single action.

The discharge will recoil the slide which, in turn, will eject the fired cartridge case, cock the hammer and compress the recoil spring. Then the slide will automatically close, feeding the

next cartridge from the magazine into the chamber.

⚠ WARNING: THE PISTOL IS STILL CHAMBER LOADED, COCKED AND READY TO FIRE AGAIN. Keep your finger away from the trigger whenever you do not intend to fire.

When the last round has been fired the slide remains open.

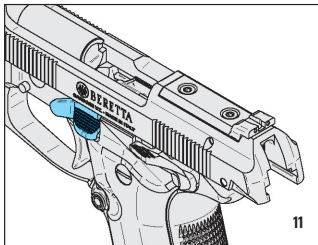

To fire again, remove the empty magazine and insert a loaded one.

Press the slide catch to close the slide and to load the chamber.

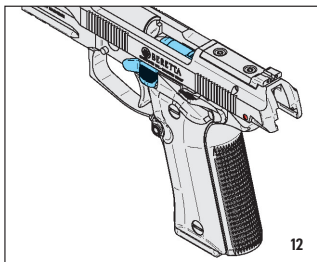

⚠ WARNING: THE PISTOL IS CHAMBER LOADED, COCKED AND READY TO FIRE AGAIN. Keep your finger away from the trigger whenever you do not intend to fire. IMMEDIATELY ENGAGE THE THUMB SAFETY.



⚠ WARNING: Always ensure that the safety is fully engaged until ready to fire. A safety is fully engaged only when the safety can move no further into the safe position. A safety which is not fully en-

gaged will not prevent weapon discharge.

When you have completed shooting, remove the magazine, check that the firing chamber is empty, see “UNLOADING” on page 16 and close the slide pushing the slide catch again.

⚠ WARNING: Always unload the firearm immediately after shooting is completed. Never store a loaded firearm. To store the pistol see the paragraph “STORAGE” on page 41.

⚠ WARNING: If while firing the trigger is pulled and the firearm does not immediately fire: **CEASE FIRING IMMEDIATELY** and do the following:

Keep the firearm pointed in a SAFE direction in the event a “hang-fire” has occurred. A hangfire occurs when there is a delay in a cartridge’s ignition.

With the pistol pointed in a SAFE direction, wait one (1) full minute.

After one (1) full minute has elapsed, completely unload the

firearm by following the instructions in this manual “UNLOADING” on page 16.

Carefully inspect your ammunition. Immediately refer to a qualified gunsmith if the striker indent on a fired cartridge’s primer is light, off-center or does not exist.

Following the instructions “FIELD STRIPPING” on page 30, field strip the pistol and look down the barrel to make sure that no obstruction exists. If a barrel obstruction is detected, a qualified gunsmith must remove the obstruction and inspect the pistol before it can be fired.

⚠ WARNING: If another cartridge is fired into an obstructed barrel, catastrophic failure can result.

⚠ WARNING: If, while firing, you hear a change in the sound of a fired cartridge, or feel a change in the amount of recoil, or detect any other irregularity, **CEASE FIRING IMMEDIATELY and do the following:**

Keep the firearm pointed in a SAFE direction. A “squib load” may have occurred. A “squib” occurs when a cartridge fires, but with insufficient force to drive the bullet out of the barrel. This can result in a dangerous bore obstruction.

With the gun pointed in a SAFE

direction, completely unload the firearm by following the “UNLOADING” on page 16. Following the instructions “FIELD STRIPPING” on page 30, field strip the pistol and look down the barrel to make sure that no obstruction exists.

⚠ WARNING: Never attempt to reuse or fire ammunition that did not fire the first time. Dispose of unfired or damaged ammunition properly, per the ammunition manufacturer’s recommendation.

DESCRIPTION

The pistol Beretta 80X is a semiautomatic handgun designed for personal defense, military and law enforcement professionals, and training for sport competitions.

SPECIFICATIONS

Model	80X
Caliber	9mm Short / 380 Auto
Approximate weight unloaded with empty magazine (g/oz)	680/24
Magazine Capacity (rounds)	Double stack 10 or 13 rounds
Rifling pitch (mm/in)	250/10
Barrel rifling	6 right handed grooves
Barrel length (mm/in)	99/3.9
Overall length (mm/in)	175/6.9
Overall width (mm/in)	35/1.4
Overall height (mm/in)	123/4.8
Sight radius (mm/in)	132/5.2
Trigger pull (kg/oz)	3,0-5,0/106-176 double action; 1,5-2,0/53-71 single action
Trigger Reset (mm/in)	2-4 / 0.078-0.157
General Operation	Semiautomatic, blow-back
Action	Double/single
Front sight	Blade, dovetailed to slide
Rear sight	Steel, notched bar, screwed to the slide
Frame	Aluminum alloy, anodized Matt finish Available in black and bronze Combat trigger guard, plastic grip panels
Slide	Steel alloy with black finishing and Acquatechshield coating
Barrel	Steel alloy with black finishing or stainless steel
Safety features	Automatic firing pin safety Ambidextrous thumb safeties

SAFETY FEATURES

THUMB SAFETY

80X pistols feature a thumb safety on the frame with hammer de-cocking device.

When the hammer is cocked, engaging the thumb safety causes the hammer to de-cock and rest on the hammer stop, locks the slide in the closed position, and disconnects the trigger.



⚠ WARNING: Always ensure that the safety is fully engaged until ready to fire. A safety is fully engaged only when the safety can move no further into the safe position. A safety which is not fully engaged will not prevent weapon discharge.

AUTOMATIC FIRING PIN SAFETY

When the trigger is not pulled completely back, a blocking device secures the firing pin and prevents it from moving forward, even if the weapon should fall from a height and strike the ground muzzle-down.

SLIDE CATCH

The slide catch is a lever that holds the slide open and rearward after the last round is fired. This allows the user to immediately determine that the pistol does not have a round in the chamber or in the magazine.

EXPOSED HAMMER

The exposed hammer allows the user to visually and immediately determine that the hammer is cocked or lowered.

OPERATIONAL FEATURES

SEMI-AUTOMATIC FIRING

80X pistols will automatically reload after each round is fired, as long as there are cartridges in the pistol.

REMOVABLE MAGAZINE

80X pistols have a quickly removable, high capacity magazine which allows rapid reloading and extended use in emergency situations.

SIMPLE FIELD STRIPPING AND CLEANING

The disassembly device is designed to allow an extremely quick and simple field stripping of the pistol and also to avoid casual or involuntary disassembly. A pistol which can be easily field stripped can be more readily cleaned. Simple cleaning makes it easier for the user to properly maintain the pistol, which helps ensure continued reliability (see "MAINTENANCE" on page 39).

SLIDE

The slide comes with special designed serrations that provide fast, easy racking of the slide.

AMBIDEXTROUS SAFETY LEVER

Ambidextrous for easier thumb access. Extended length and width.

SIGHTS

Front sight is blade, removable, dovetailed to the slide. Rear sight is notched bar screwed to the slide.

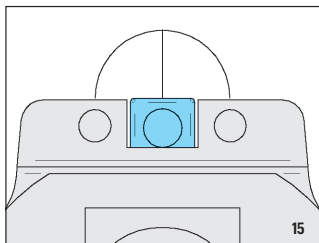

Front sight removing direction is from right to left.

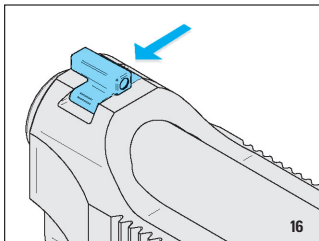

CAUTION: it is recommended to refer to a qualified gunsmith to replace and adjust the sights of your 80X.

CHECKERED FRONT AND BACKSTRAP

The front and back straps of the grip are checkered to secure a firm hold even with wet hands, or under conditions of rapid, not aimed fire.

LOADED CHAMBER INDICATOR

When a cartridge is chambered, the extractor head protrudes outside the slide breech, exposing a red warning signal. The protrusion can be felt by touch. This makes it unnecessary to pull back the slide to verify if the chamber is loaded.

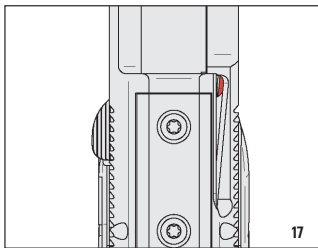

The tab is located on the right side of the pistol's slide, near the chamber, and can be both seen and felt, allowing the user to check the chamber at night by feel or during the day by checking for the increased protrusion of the red tab.

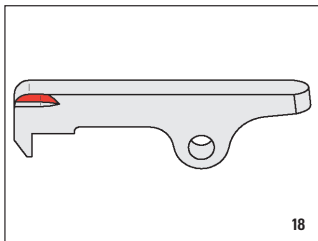

WARNING: The only certain way to check whether a pistol is loaded is to pull back the slide and visually inspect the chamber for a round.

⚠ WARNING: 80X pistols are **NOT** provided with a magazine safety. They are therefore capable of firing, if a round is chambered, even if the magazine has not been inserted or if it has been removed or if it has been removed from its seat.

REVERSIBLE MAGAZINE RELEASE BUTTON

The magazine release button can easily be assembled on either side of the pistol for right and left handed shooters.

SKELETONIZED HAMMER

The skeletonized hammer gives the pistol a distinctive look.

ACCESSORY RAIL

80X comes with an accessory rail under the frame in front of the trigger guard which is compatible with a most rail mounted accessories available

on the market.

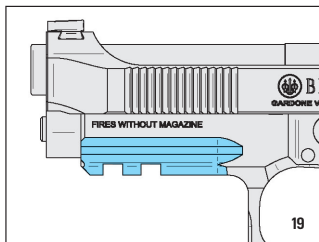

RED DOT AIMING DEVICE

80X slide allows installation of a red dot aiming device. Mounting plates are available for many red dot aiming devices.

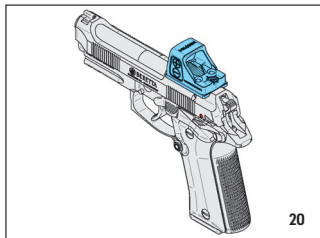

GENERAL OPERATION

The Beretta 80X pistols are semiautomatic firearms working on the blow-back principle. Upon firing, the pressure developed by the combustion gases recoils the slide which, during its rearwards movement, extracts and ejects the fired cartridge case, cocks the hammer and activates the recoil spring.

The slide will then automatically move forwards to the closed position, feeding the next cartridge from the magazine into the chamber.

The slide is designed to stay open after the last round has been fired and ejected.

LOAD CHECK

⚠ WARNING: Keep your finger **OFF OF THE TRIGGER** and the barrel pointed in a **SAFE** direction when checking to be certain your 80X pistol is unloaded.

To visually check that your pistol is unloaded, carefully follow the steps below.

Remove the magazine by depressing the magazine release button.

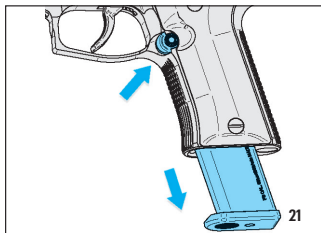

Retract the slide and visually inspect the cartridge chamber. The pistol is unloaded when no cartridge is visible when looking into the open chamber.

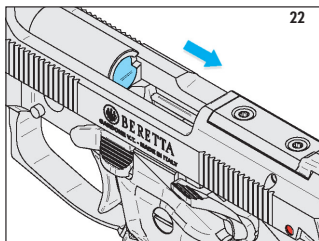

For safety, you should... Always visually check to see that the chamber is unloaded. Never assume that a firearm is unloaded (even with a gun that is new and in its original pack-

aging).

Never point a firearm toward yourself or another person.

Lock the slide in the open position and remove the magazine before handing the pistol to another person.

Never take any pistol from another person unless the slide has been locked open, the magazine has been removed and the chamber has been visually checked to confirm it is unloaded.

LOCKING THE SLIDE TO THE REAR

⚠ WARNING: Keep your finger **OFF OF THE TRIGGER** and the barrel pointed in a **SAFE** direction.

⚠ WARNING: Always keep your finger away from the ejection port.

Locking the slide in the open position can be accomplished in 2 ways.

1) insert an empty magazine into the pistol. Retract the slide until the slide locks in the open position.

⚠ Notice: The slide will be released when pulled to the rear if a **LOADED** magazine is inserted.

⚠ Notice: The slide will be released when pulled to the rear if **NO** magazine is inserted.

⚠ Notice: The slide will remain locked in the open position when the magazine is removed.

2) with no magazine in the pistol, retract the slide while pressing up on the slide catch to lock the slide in the open position.

FIELD STRIPPING

⚠ WARNING: Make sure the pistol is unloaded. If not, unload it following the procedure "UNLOADING" on page 16.

⚠ WARNING: Always point the firearm in a safe direction. Keep your finger away from the trigger.

⚠ WARNING: It is recommended to wear protective glasses when performing maintenance operations.

⚠ CAUTION: It is advisable to carry out the field stripping and the assembly operations over a table to catch components should they drop.

Remove the magazine by depressing the magazine release button.

Hold the pistol in the right hand and with left forefinger press the disassembly latch release button which protrudes from the right side of the pistol. While it is held in, rotate the disassembly latch on the left side of the frame with the thumb clockwise approx. 90° downward.

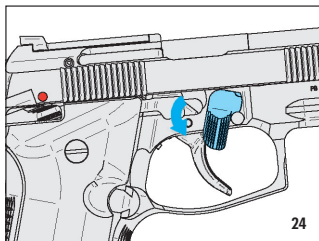

Pull the slide-barrel assembly with locking block, recoil spring and spring guide forwards

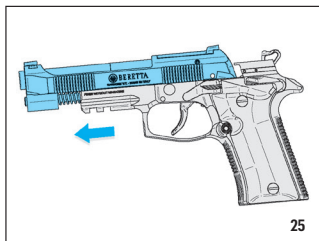

Slightly press recoil spring and spring guide and lift it to re-

move it from the slide.

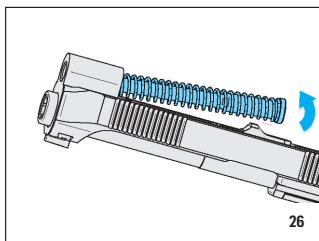

Remove the barrel from the slide

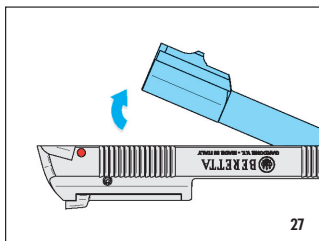

CAUTION: No further disassembly is recommended unless done by a competent gunsmith.

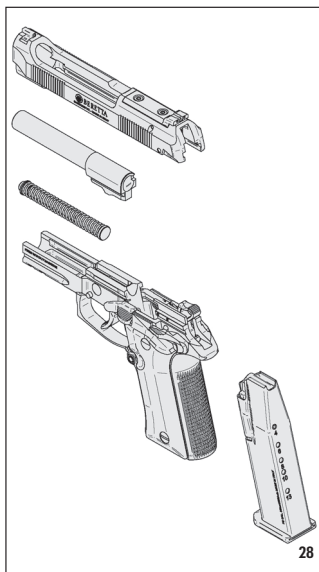

RE-ASSEMBLY

Assemble the pistol following the Field Stripping procedure in reverse order. It is advisable to pay attention to the following points:

When the barrel is correctly inserted into the slide, it should rest securely inside the slide without movement. (The extractor must lie in its groove in the barrel).

The recoil spring guide head should lodge in the center of its groove in the barrel lug.

When the slide and barrel assembly are placed back on the frame, the slide/barrel assembly should be pushed beyond the rear of the frame (or aligned with it) before the disassembly latch is rotated into its original position.

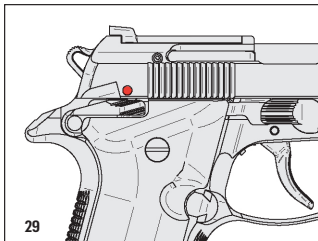

HOW TO REPLACE THE MAGAZINE RELEASE BUTTON

⚠ WARNING: Make sure the pistol is unloaded. If not, unload it following the procedure "UNLOADING" on page 16.

⚠ CAUTION: Before proceeding with the disassembly of the parts, closely observe and memorize the position of the components to make assembly easier.

⚠ Notice: It is advisable to perform field stripping and assembly operations over a table to catch components should they drop.

With a suitable screwdriver unscrew and remove the grip panels.

Press the back (not protruding side) of the magazine release button down and away. The magazine release assembly will then drop out.

Insert the new magazine release button in position tilting it

slightly (protruding side on the right side of the frame).

Holding the button (protruding side) of the magazine release assembly firmly in place, press its not protruding side and push it until it clicks into place. The operation is done correctly when the magazine slides easily into its housing.

Replace grip panels with screws.

HOW TO REVERSE THE MAGAZINE RELEASE BUTTON

 **WARNING:** Make sure the pistol is unloaded. If not, unload it following the procedure “UNLOADING” on page 16.

 **CAUTION:** Before proceeding with the disassembly of the parts, closely observe and memorize the position of the components to make assembly easier.

 **Notice:** It is advisable to perform field stripping and assembly operations over a table to catch components should they drop.

With a suitable screwdriver unscrew and remove the grip panels.

Press the back (not protruding side) of the magazine release button down and away. The magazine release assembly will then drop out.

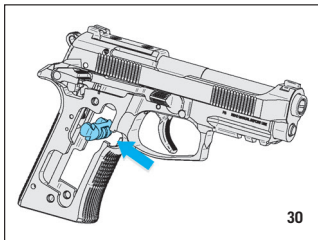

Reverse the magazine release assembly and insert the button in position tilting it slightly (not protruding side on the left side of the frame).

Holding the button (not protruding side) of the magazine release assembly firmly in place, press its protruding side and push it until it clicks into place. The operation is done correctly when the magazine slides easily into its housing.

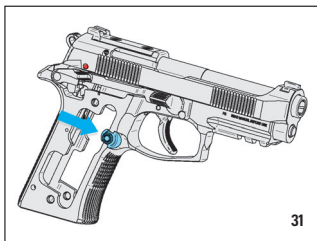

Replace grip panels with screws.

AIMING DEVICE

INSTALLATION

⚠ WARNING: Make sure the pistol is unloaded. If not, unload it following the procedure "UNLOADING" on page 16.

To install the red dot aiming device, remove the cover plate with rear sight from the slide of your 80X Optic Pistol by unscrewing the two Torx screws (socket countersunk M3X5) using a Torx T10 key.

⚠ Notice: Use the chart at page 37 to select the proper mounting plate and screws for your aiming device.

Install the mounting plate on top of the slide and fasten it by means of the two socket countersunk Torx screws M3X5 using a Torx T10 key.

⚠ WARNING: a sight which is not mounted securely may become detached upon recoil of firearm. If it becomes

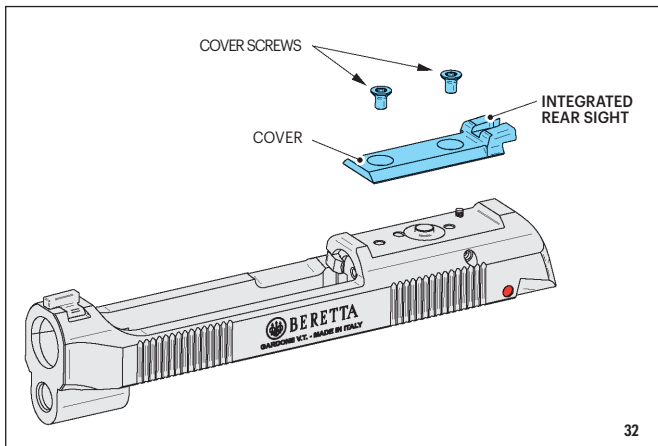

detached it may fly back and strike the shooter or bystander and cause injury. Observe the condition of the mounting screws after firing. If the mounting screws show signs of loosening **DO NOT** fire the gun again until you have re-tightened the screws. The original screws come with a drop of glue applied; if it could not be enough the use of Loctite® is recommended.





Install your aiming device on the mounting plate.

Using the screws, fasten the sight onto the slide using an allen key. Details on different screws and keys are given in the chart at page 37.

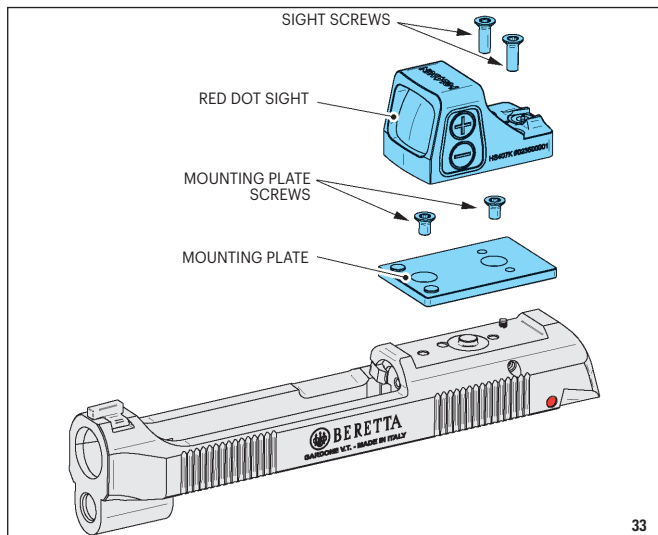
If required replace of the front sight.

CAUTION: it is recommended to refer to a qualified gunsmith to replace and adjust the sights of your 80X.

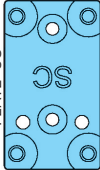
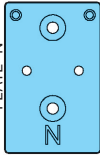
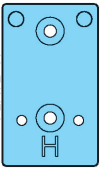

FRONT SIGHT	 HIGHER SIGHT	SIGHT INSTALLED ON THE PISTOL	 HIGHER SIGHT
SOCKET COUNTERSUNK TORX SCREW M3X9 (TORX T10 KEY) 			HOLOSUN HS407K
SOCKET COUNTERSUNK TORX SCREW M3X7 (TORX T10 KEY) 		NOBLEX QUICK SIGHT 5.0	
SOCKET COUNTERSUNK TORX SCREW M3X5 (TORX T10 KEY) 	SHIELD SMS		
34	PLATE "SC" 	PLATE "N" 	PLATE "H" 

REMOVAL

 **WARNING:** Before installing or removing the aiming device, unload the pistol in accordance with the unloading procedure of the User Manual. Unload the magazine in accordance with the User Manual.

To remove the red dot aiming device, unscrew the fastening screws and remove them and the device. Details on different screws and keys are given in the chart at page 37.

Then remove the mounting plate by unscrewing the fastening screws using a suitable key.

Install the cover plate with rear sight on the slide of your 80X pistol fastening it by means of two socket countersunk Torrx screws M3X5 using a Torx T10 key.

If you have used the higher front sight replace it with the original front sight.

 **CAUTION:** it is recommended to refer to a qualified gunsmith to replace and adjust the sights of your 80X.

MAINTENANCE

Every day the pistol is fired or at least once a month, cleaning and lubricating is recommended.

⚠ WARNING: Excess oil and grease obstructing the bore, even partially, is very dangerous when firing and may cause barrel rupture and serious injury to the shooter and bystanders. Never spray or apply oil to the cartridges. Use lubricants properly. You are responsible for the proper care and maintenance of your firearm.

⚠ CAUTION: Always keep the outside surface of the firearm slightly lubricated, to allow the surface coating treatment to last.

BARREL

Spray a copper brush with Beretta oil or a good grade gun oil. Insert the brush into the barrel from the chamber and scrub the chamber and bore thoroughly. If necessary, first clean the bore with a gun solvent.

Dry the chamber and bore by pushing a cotton patch through the chamber and bore with the brush. Change the patch until it emerges clean.

Clean the exterior of the barrel with a cotton patch soaked in Beretta oil or a good grade gun oil. If necessary use a brush.

Lightly oil the inside of the barrel by passing through it a clean cotton patch soaked in Beretta oil or a good grade gun oil. Lightly oil the locking block and outside of the barrel.

⚠ WARNING: Do not clean the barrel with the pistol assembled.

ⓘ Notice: Cleaning the barrel from the breech (chamber) end will avoid damaging the muzzle or bore.

SLIDE

Clean the slide with a patch and Beretta oil or a good grade gun oil, paying special attention to the breech face and extractor, slide rails and underside of the breech. If necessary, use a metal brush. Wipe slide surfaces with a clean patch. Lightly oil the slide.

FRAME

With a cotton patch soaked in Beretta oil or a good grade gun oil, clean all areas covered by gunpowder residue and dirt.

Wipe outer frame surfaces clean and lightly lubricate the rails and moving parts. Lightly oil the disassembly latch, magazine release button, slide stop, trigger, hammer, safeties and the trigger mechanism levers.

Lightly oil the frame.

RECOIL SPRING AND SPRING GUIDE

Lightly oil the recoil spring and spring guide with Beretta oil or a good grade gun oil. After long use it could be necessary to first scour these parts using a metal brush.

MAGAZINE

Make sure the magazine is thoroughly clean and the follower slides easily downward if pressed.

If necessary, lightly oil with Beretta oil or a good grade gun oil the internal walls of the magazine box.

Run a dry patch through the box. Do not leave lubricant inside the magazine box.

 **CAUTION:** Do not apply excess oil. Accumulation of oil attracts dirt and dust, which can interfere with the functioning and reliability of the firearm.

STORAGE

 **WARNING:** Always store the pistol **UNLOADED**, with the magazine empty.

 **WARNING:** Always store your firearm so that children can not gain access to it. To reduce the risk of accidents involving children, unload your firearm, lock it and store the ammunition in a separate locked location. (See point 3 of the **BASIC SAFETY RULES**).

 **CAUTION:** Before storage, always check the conditions of the pistol and its case. Make sure the case is dry and that the firearm is dry and oiled. Traces of moisture or drops of water could damage the pistol.

TROUBLE-SHOOTING

⚠ WARNING: Do not attempt to make repairs to any firearm without proper knowledge or training. Do not alter parts or use substitute parts not made by Beretta. Any alterations or adjustments that may be necessary to the operating mechanism should be performed by the Manufacturer or by its Local Official Distributor.

⚠ WARNING: Do not attempt to alter the internal parts of your pistol's firing mechanism. Altering internal parts can cause an unsafe condition.

⚠ WARNING: Altering the internal parts of your pistol's firing mechanism voids the manufacturer's warranty.

MALFUNCTION	PROBABLE CAUSE	REMEDY
Failure to feed a cartridge into the chamber	Defective cartridge	Inspect and replace the cartridge
Failure to fire	Defective cartridge	See instructions given in paragraph "FIRING" on page 19
Failure to extract	Dirty cartridge chamber	Clean and lubricate the cartridge chamber
	Defective or dirty ammunition	Replace or clean cartridge
	Dirt under the extractor	Clean the extractor seat



PARTS LISTING

POS.	DESCRIPTION
1	BARREL
2	RECOIL SPRING ASSEMBLY
3	SLIDE
4	FRONT SIGHT
5	EXTRACTOR
6	EXTRACTOR SPRING
7	EXTRACTOR PIN
8	COVER PLATE WITH REAR SIGHT
9	COVER PLATE SCREW
10	FIRING PIN SPRING
11	FIRING PIN
12	FIRING PIN STOP PIN
13	FIRING PIN CATCH SPRING GUIDE
14	FIRING PIN CATCH SPRING
15	FIRING PIN CATCH
16	FRAME
17	TRIGGER
18	TRIGGER SPRING
19	TRIGGER BAR
20	SLIDE CATCH
21	SLIDE CATCH SPRING
22	DISASSEMBLING LATCH
23	DISASSEMBLING LATCH RELEASE BUTTON
24	TRIGGER BAR SPRING
25	FRONT EJECTOR PIN
26	REAR EJECTOR PIN
27	FIRING PIN CATCH LEVER
28	FIRING PIN CATCH LEVER SPRING
29	EJECTOR
30	HAMMER STOP SPRING
31	HAMMER STOP
32	HAMMER
33	HAMMER SPRING GUIDE
34	SAFETY SPRING PIN
35	SAFETY LEVER, RIGHT
36	TRIGGER RELEASE LEVER
37	HAMMER PIN
38	SAFETY LEVER, LEFT
39	SAFETY LEVER PLUNGER
40	SAFETY LEVER SPRING
41	SEAR PIN
42	SEAR SPRING PIN
43	SEAR
44	SEAR SPRING
45	HAMMER SPRING CAP PIN
46	MAGAZINE RELEASE BUTTON
47	MAGAZINE RELEASE BUTTON SPRING GUIDE, LEFT
48	MAGAZINE RELEASE BUTTON SPRING
49	MAGAZINE RELEASE BUTTON SPRING GUIDE, RIGHT
50	HAMMER SPRING
51	HAMMER SPRING CAP
52	PANEL BUSH
53	SPRING WASHER
54	PANEL SCREW
55	RIGHT GRIP PANEL
56	LEFT GRIP PANEL
57	MAGAZINE

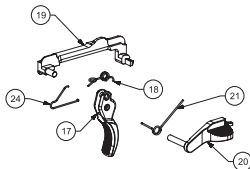
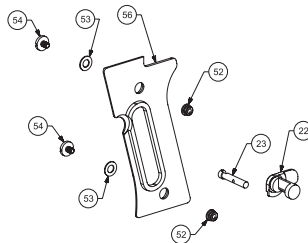
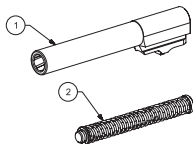

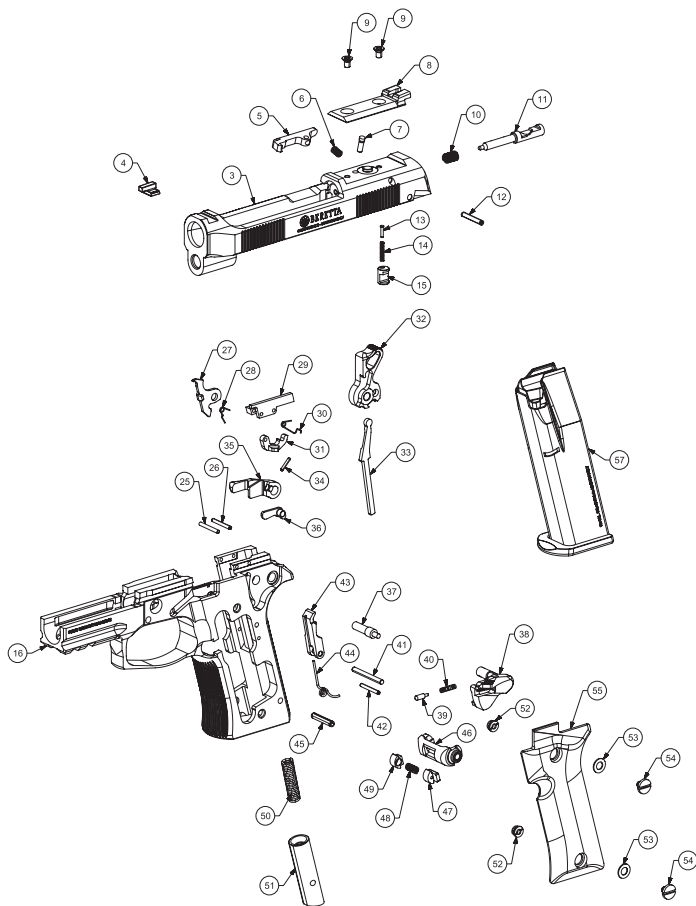

SERIAL NUMBER:

DATE PURCHASED:

PURCHASE PRICE:

DEALER INFORMATION:

The illustrations and descriptions given in this brochure are intended as a general guide only, and must not be taken as binding. The Company, therefore, reserves the right to make, at any moment and without prior notice, any changes it thinks necessary to improve its models or to meet any requirements of manufacturing or commercial nature.

.....

.....

.....

.....

.....

.....

.....

.....

.....

.....

.....

.....

.....

.....

FIRST ISSUE: DECEMBER 2022

80X
PISTOL
USER MANUAL

80X

PISTOL USER MANUAL



FABBRICA D'ARMI P. BERETTA S.P.A.
VIA PIETRO BERETTA, 18
I 25063 GARDONE VAL TROMPIA, BRESCIA, ITALY

BERETTA.COM